

Körös-Road Kft.
5600 Békéscsaba,
Batthyány u. 4.

Létesítmény megnevezése:

**Füzesgyarmat,
nyugati elkerülő út
engedélyezési terve**

Méretarány:

M=1:100

Dokumentáció megnevezése:

Keresztszelvények

Rajzterület:

Felelősség:

Szerkesztette:

Tervezte:

Név:

Vágási Tibor

Károlyi László; Vágási Tibor

Jogosultság:

KÉ/04-0509

KÉ/04-0372; KÉ/04-0509

Aláírás:

2018.10.

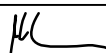

2018.10.

Dátum:

2018.10.

2018.10.

Rajzszám:

6.

KSZELV. 17

Fgy-t

SZ. = 175.000
 ZTER= 86.105
 ZPSZ= 86.550

MH = 1/ 100
 MZ = 1/ 100
 AM = 82.0

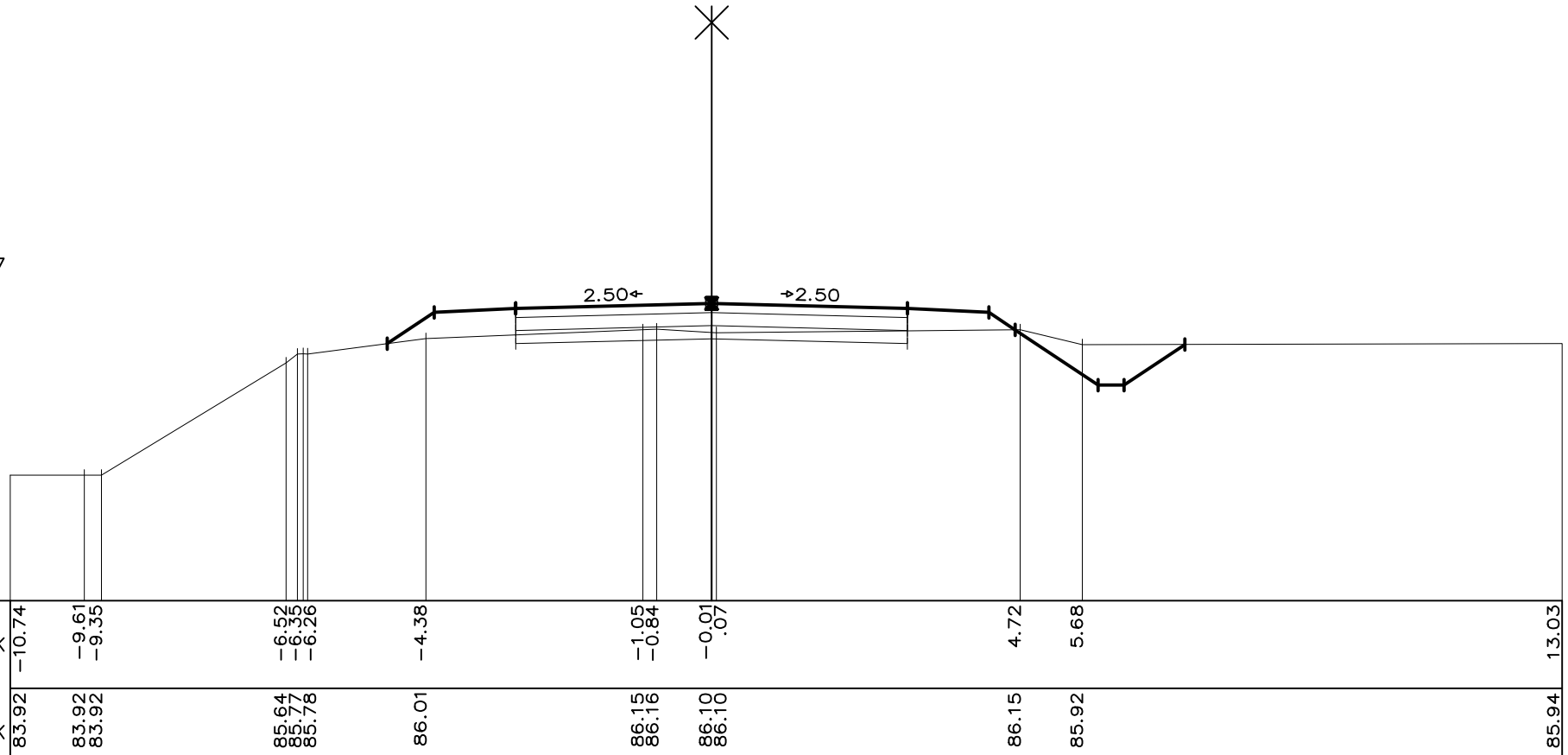

TEREP	TÁVOLSÁGOK	-10.74	-9.61	-9.35	-6.52	-6.35	-6.26	-4.38	-1.05	-0.84	-0.01	.07	4.72	5.68	13.03
	MAGASSÁGOK	83.92	83.92	83.92	85.64	85.77	85.78	86.01	86.15	86.16	86.10	86.10	86.15	85.92	85.94
TERVEZETT	TÁVOLSÁGOK				-4.97	-4.25	-3.00	.00	3.00	4.25	4.65	5.92	6.32	7.25	
	MAGASSÁGOK				85.93	86.41	86.48	86.55	86.48	86.41	86.15	85.30	85.30	85.92	

KSZELV. 21

Fgy-t

SZ. = 275.000
 ZTER= 86.293
 ZPSZ= 86.767

MH = 1/ 100
 MZ = 1/ 100
 AM = 82.0

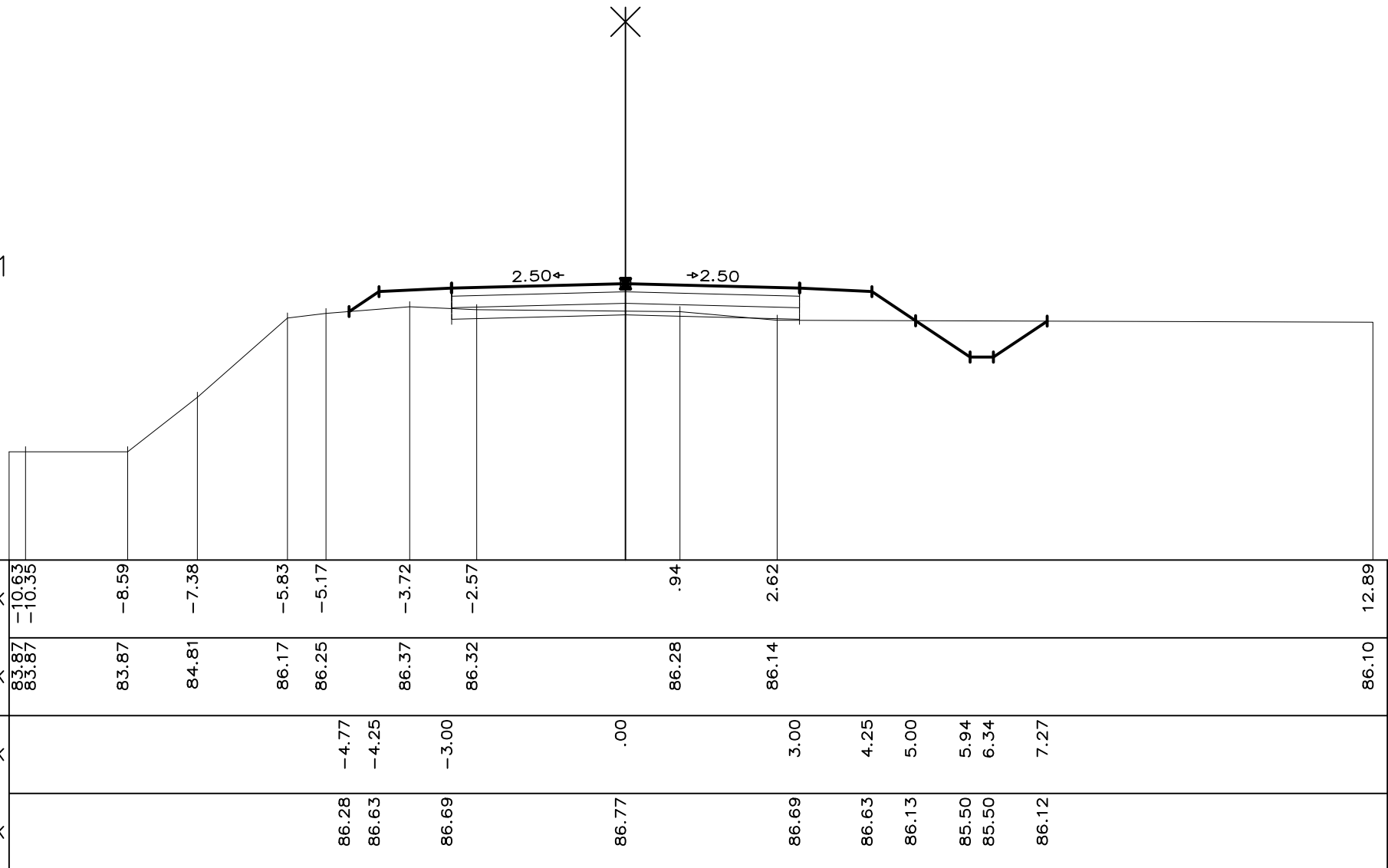

KSZELV. 28

Fgy-t

SZ. = 375.000
 ZTER= 86.562
 ZPSZ= 86.983

MH = 1/ 100
 MZ = 1/ 100
 AM = 82.0

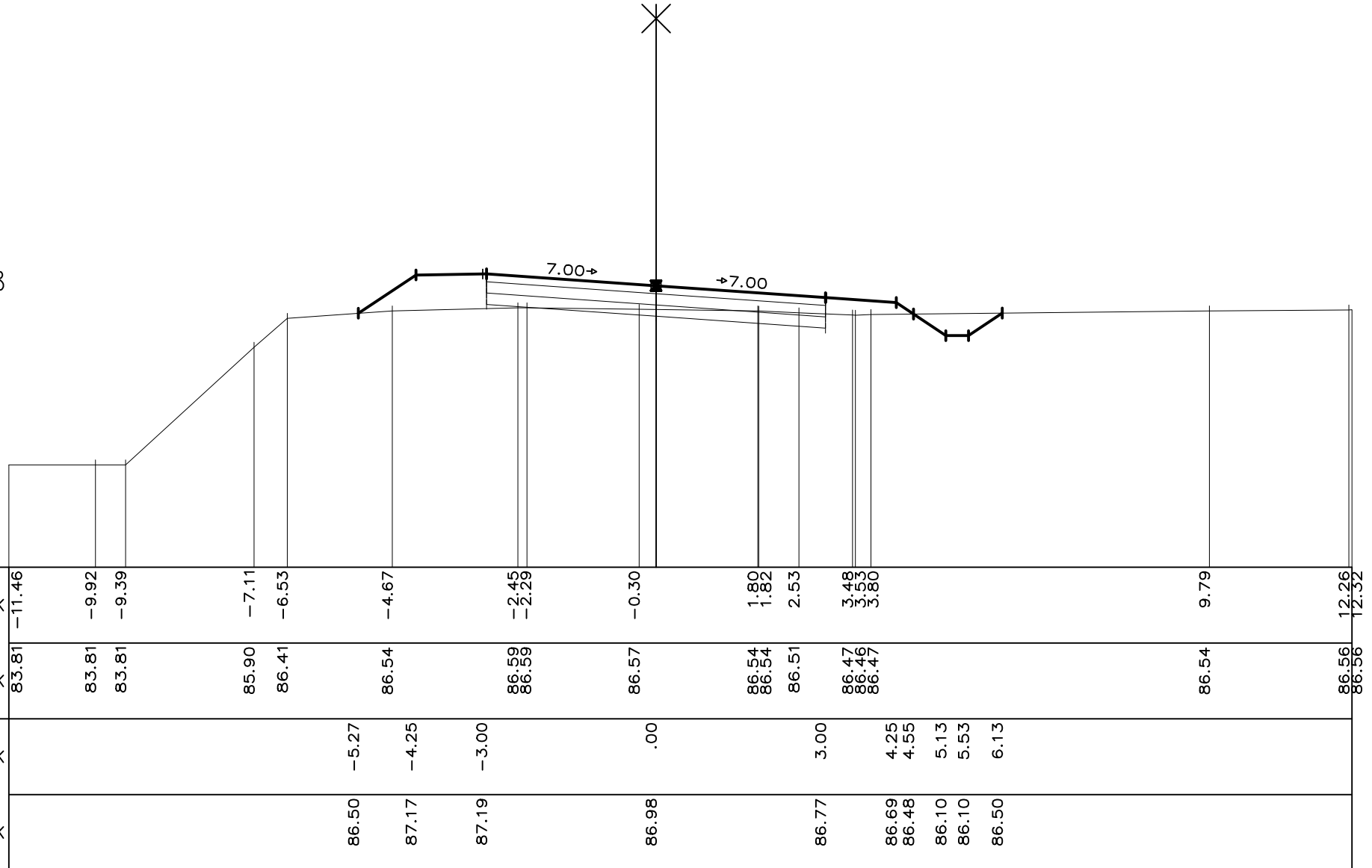

KSZELV. 33

Fgy-t

SZ. = 475.000
 ZTER= 86.628
 ZPSZ= 87.200

MH = 1/ 100
 MZ = 1/ 100
 AM = 82.0

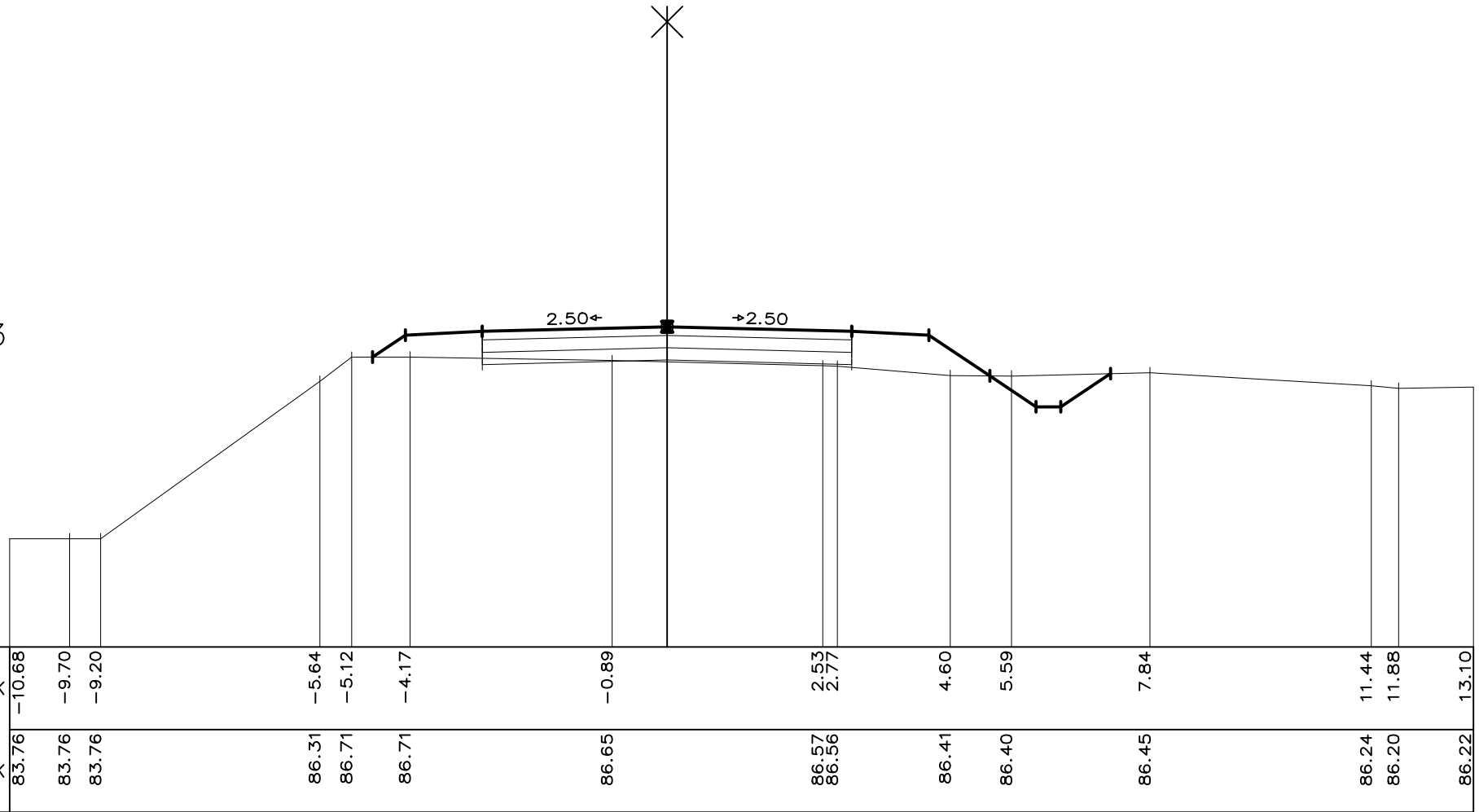

TERVEZETT	TÁVOLSÁGOK	MAGASSÁGOK
	-4.78	86.71
	-4.25	87.06
	-3.00	87.12
	.00	87.20
	3.00	87.12
	4.25	87.06
	5.24	86.40
	5.99	85.90
	6.39	85.90
	7.20	86.44

KSZELV. 37

Fgy-t

SZ. = 575.000
 ZTER= 86.828
 ZPSZ= 87.416

MH = 1/ 100
 MZ = 1/ 100
 AM = 82.0

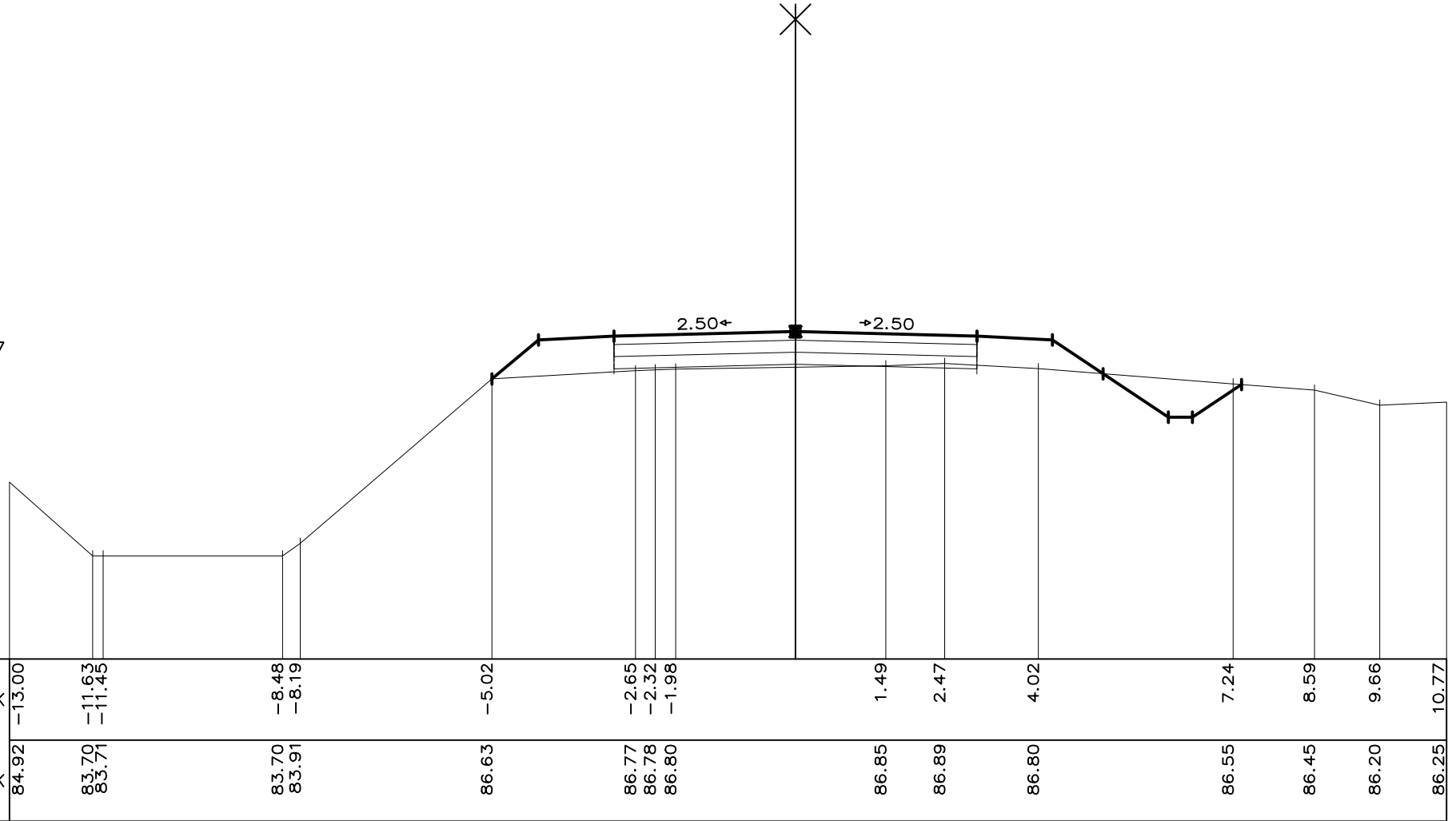

TEREP	TÁVOLSÁGOK	-13.00	-11.63	-8.48	-5.02	-2.65	1.49	2.47	4.02	7.24	8.59	9.66	10.77	
	MAGASSÁGOK	84.92	83.70 83.71	83.70 83.91	86.63	86.77 86.78 86.80	86.85	86.89	86.80	86.55	86.45	86.20	86.25	
TERVEZETT	TÁVOLSÁGOK				-5.02	-4.25	-3.00	.00	3.00	4.25	5.09	6.17	6.57	7.38
	MAGASSÁGOK				86.63	87.28	87.34	87.42	87.34	87.28	86.72	86.00	86.00	86.54

KSZELV. 45

Fgy-t

SZ. = 675.000
 ZTER= 86.506
 ZPSZ= 87.560

MH = 1/ 100
 MZ = 1/ 100
 AM = 82.0



Terv. aszfalt sárrázó csatlakozása

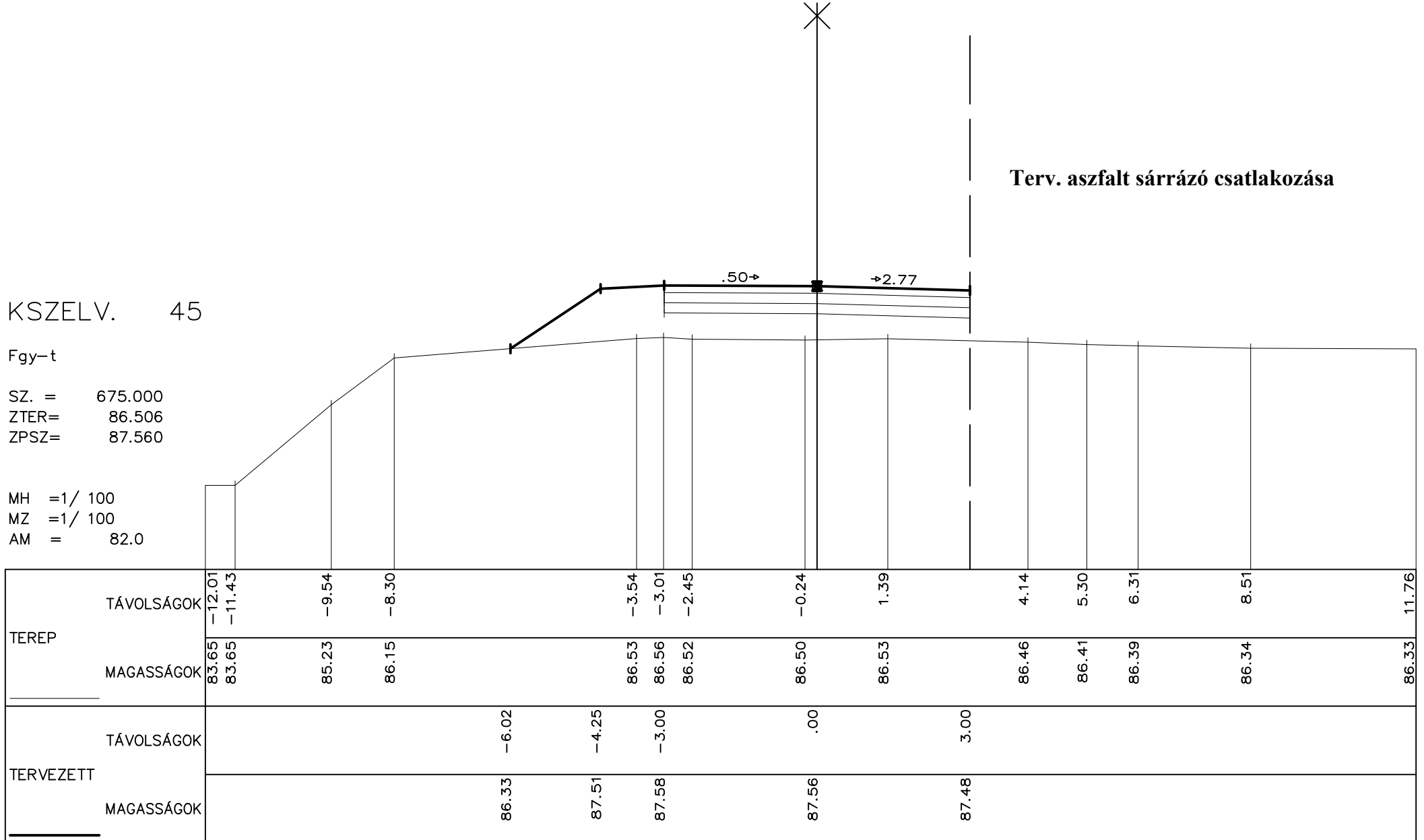

KSZELV. 69

Fgy-t

SZ. = 875.000
 ZTER= 86.059
 ZPSZ= 87.032

MH = 1/ 100
 MZ = 1/ 100
 AM = 84.0

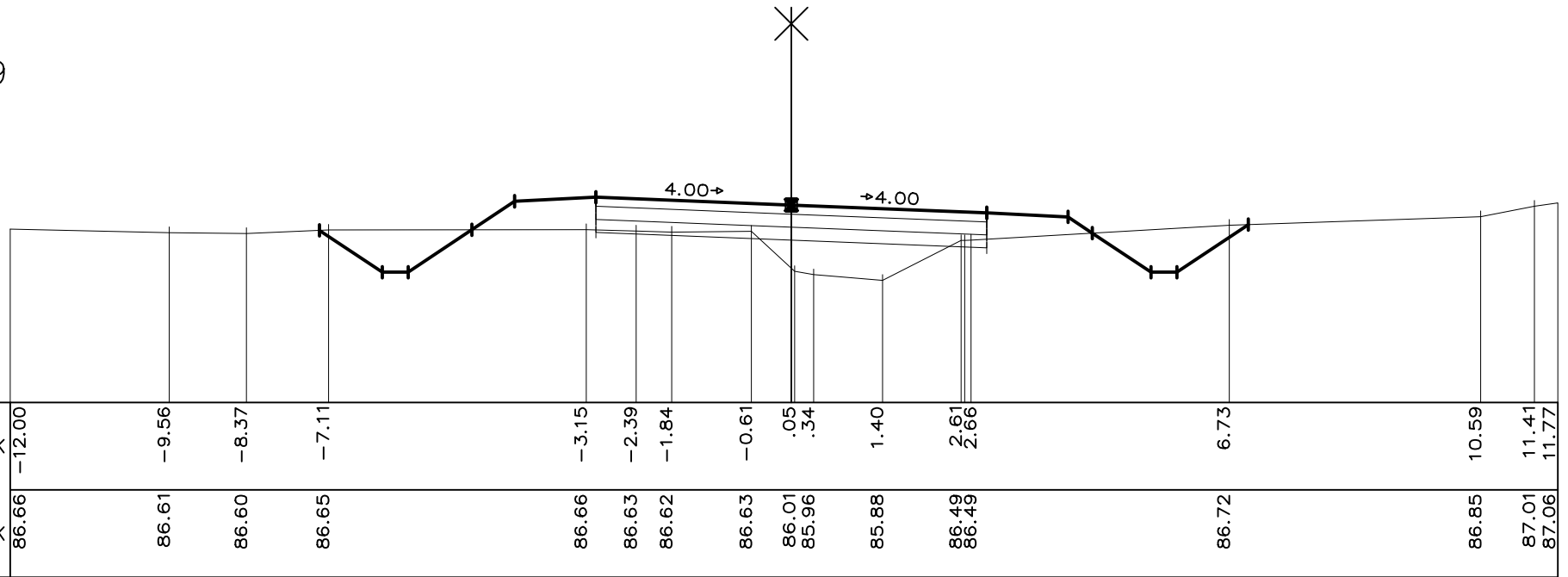

TEREP	TÁVOLSÁGOK	-12.00	-9.56	-8.37	-7.11			-3.15	-2.39	-1.84	-0.61	.05	.34	1.40	2.61	2.66			6.73			10.59	11.41	11.77
	MAGASSÁGOK	86.66	86.61	86.60	86.65			86.66	86.63	86.62	86.63	86.01	85.96	85.88	86.49	86.49			86.72			86.85	87.01	87.06
TERVEZETT	TÁVOLSÁGOK				-7.25	-6.28	-5.88	-4.91	-4.25	-3.00		.00			3.00			4.25	4.62	5.52	5.92	7.02		
	MAGASSÁGOK				86.64	86.00	86.00	86.65	87.09	87.15		87.03			86.91			86.85	86.60	86.00	86.00	86.73		

KSZELV. 79

Fgy-t

SZ. = 975.000
 ZTER= 86.982
 ZPSZ= 87.231

MH = 1/ 100
 MZ = 1/ 100
 AM = 85.0

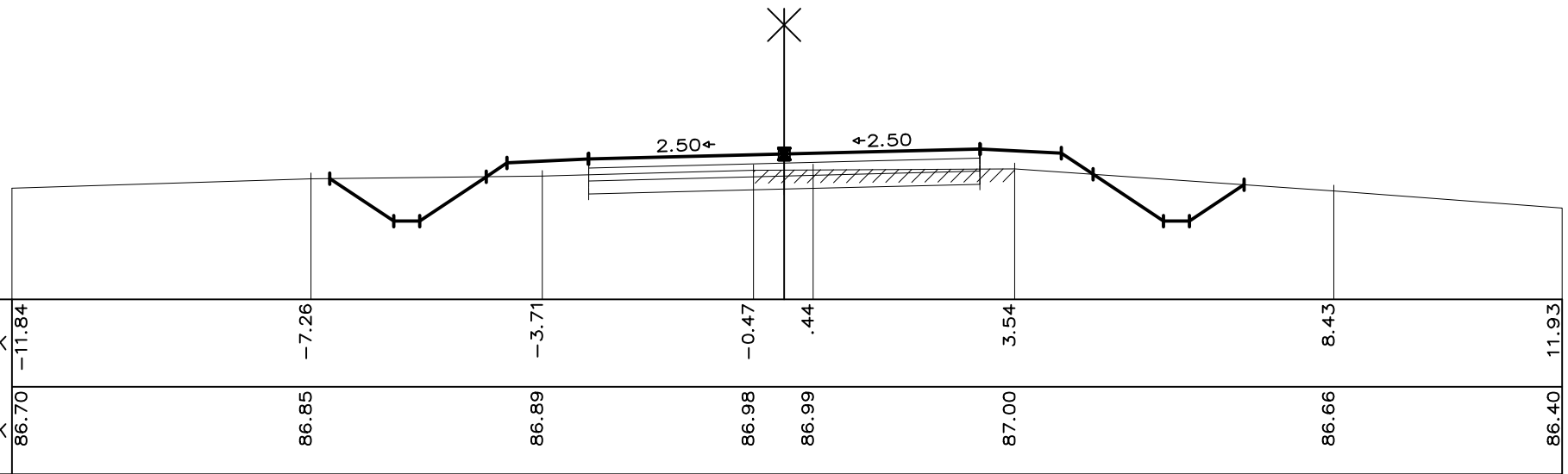

TEREP	TÁVOLSÁGOK	-11.84	-7.26	-3.71	-0.47	.44	3.54	8.43	11.93				
	MAGASSÁGOK	86.70	86.85	86.89	86.98	86.99	87.00	86.66	86.40				
TERVEZETT	TÁVOLSÁGOK	-6.97	-5.99	-4.57	-3.00	.00	3.00	4.25	4.73	5.81	6.21	7.05	
	MAGASSÁGOK	86.85	86.20	86.20	86.88	87.09	87.16	87.23	87.31	87.24	86.92	86.20	86.20